

# FCUS0542



## Disinfection Air Sanitizing Fogger



Sterilizer Air Disinfector



**High  
efficiency  
antivirus**

**Highly effective  
antibacterial**



## Sterilizer air disinfectant virus killer

The mist of hypochlorous acid with strong oxidizing property is attached on aerosol/dust particles to effectively eliminate viruses

**Sterilizer Rate 99.9%**

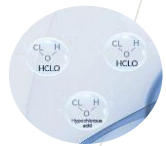

### In Public

Public places contain lots of bacterium



### Kindergarten

baby crawling gives more opportunities for bacterium to invade



### Every living corners

bacteria hide within outerwear

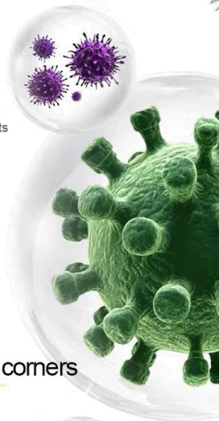

## Sterilizer air disinfectant virus killer



Description	Disinfectant Atomizing
Model No.	FCUS0542
Operating voltage	220-240V
Rated frequency	50-60Hz
Rated power	48W
Amount of humidity	480mL/h
Water capacity	16L
Noise	≤35dB(A)

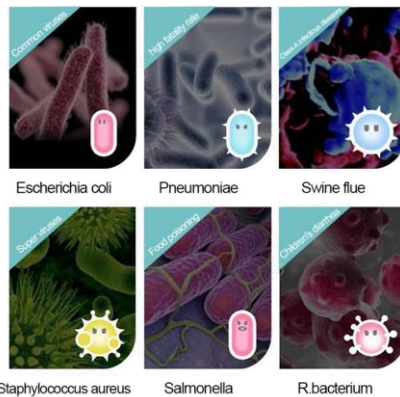

Escherichia coli    Pneumoniae    Swine flue  
Staphylococcus aureus    Salmonella    R.bacterium

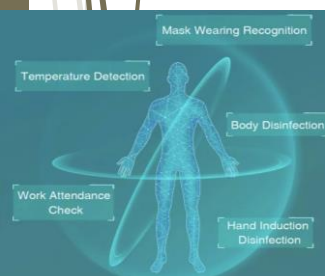

dining room



living room



Bedrooms



## Sterilizer air disinfectant virus killer

### Product working principle

Disinfectant Atomizing / Air humidifier is based on ultrasonic can produce 200 million times high frequency oscillation per second, and then atomize the water into 1~5 microns particles, further spread the water mist into air by fan.

When the room humidity is 45~60%RH and the room temperature is 20~25 degrees, they will be in optimal state for health & mind. It is suitable for working & resting condition.

It can prevent static electricity & generate anion. It is good for treating and delaying some diseases, as influenza, hypertension & bronchitis, etc.

### Product features

1. Humanized design: larger capacity water tank for extending continuous working time.
2. Remote control function
3. Touch pad.
4. Timer function.
5. Safety protection system: automatic power off when water shortage.
6. Controllable humidity ratio.
7. Sleep function

### Products and accessories



1

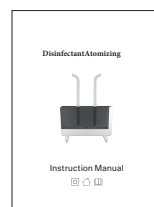

2



3

1. Disinfectant Atomizing
2. Instruction manual
3. Remote control



# Sterilizer air disinfectant virus killer

## Product structure

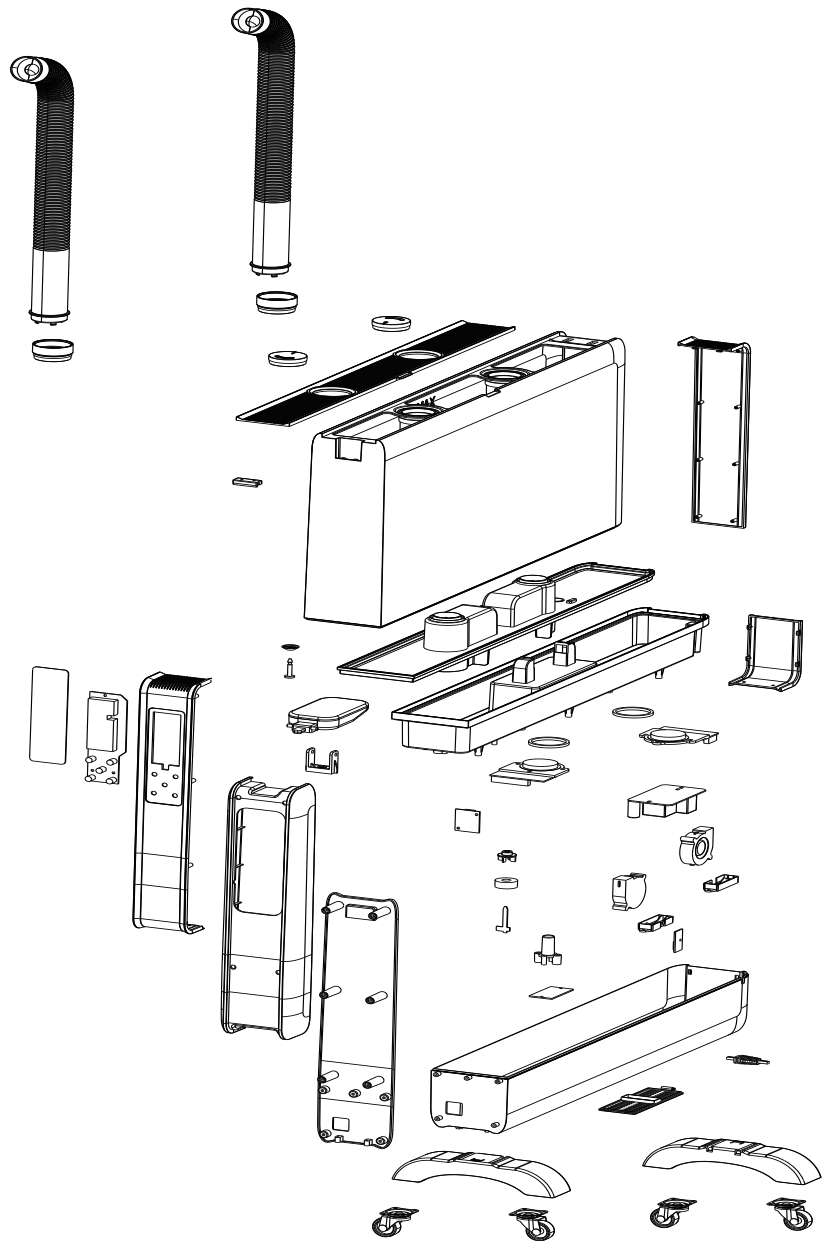

## Sterilizer air disinfecter virus killer

### Using directive

1. Open the packaging and remove the product.
2. Remove product plastic bag packaging.
3. Remove the water tank, open the cover and fill the water tank with room-temperature water (the temperature can not higher than 40°C or too cold).
4. Put the water tank back on the base, put the water tank cap on.
5. Install the mist outlet nozzle or mist outlet tube.
6. Power on.

### Function menu



**Power:** Press the "Power" button, the air humidifier start working and the touch pad lights up. Press again is off.



**Humidity:** Set the humidity, 40, 45,50, 55, 60, 65, 70, 75, 80,85 and 90% RH for optional. Touch pad shows the relative humidity is the current room on initial status. Press "Humidity" button, the humidity circularly display ranges by low-high-shut down grade & touch pad flashes. After setting the humidity for 5 seconds, touch pad restores the current relative humidity. When the room humidity reaches the seting value, it stops working.





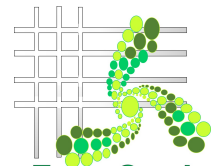

Free Cool  
www.freecoolsystems.com

FCUS0542

## Sterilizer air disinfectant virus killer



**Timer:** Press "Timer" button, timer function activates, and timer setting ranges from 1~12 hours, the touch pad displays rest time.



**Fogmeter:** Press the "Fogmeter" button, it can adjust the amount of fogmeter. Each time press this button, the fogmeter circularly varies from low-middle-high grade, meanwhile the touch pad correspondingly displays 1, 2 and 3. It can control the two spray tube separately.



**Sleep:** Press "Sleep" button, sleep function activates. In working mode, activates sleep function, touch pad auto shut off & shows "Sleep" icon after 5 seconds, then keep working with a setting humidity 65%RH. Press any button, touch pad on. When touch pad on, press any button to shut off this function.



Water shortage

**Water shortage:** When no water or drops below limited level, safety protection system starts, red water shortage icon is flashing, the machine alarms, then automatically shuts down.

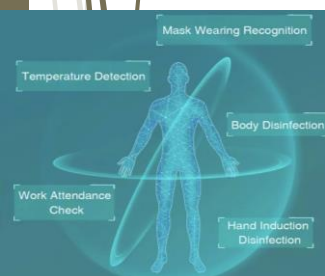
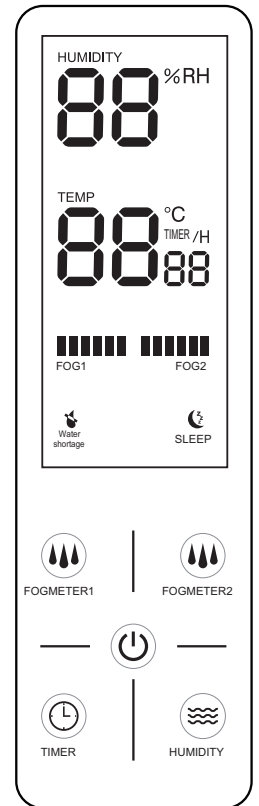



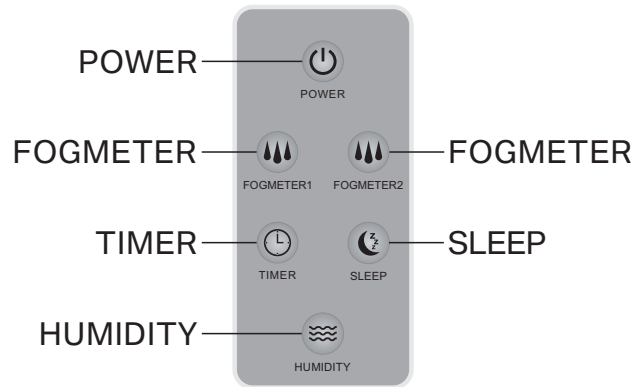

## Sterilizer air disinfectant virus killer

### Remote control menu



The operation of remote control is the same as above touch pad. Please align with the remote receiving window on the front panel & avoid obstacles.

-  Power: Power On / Off control.
-  Fogmeter: Fogmeter control.
-  Timer: Timer control.
-  Sleep: Sleep control.
-  Humidity: Humidity control.

### Matters needing attention

#### Security Guide

- Please study this instruction manual carefully before using the product. Keep it for reference.

#### Dangerous Instruction

- Do not allow liquid (such as water) or (flammability) cleanser to enter into the components at the bottom of product, lest the electric shock or fire disaster happens.
- Do not immerse the air humidifier into water, any other liquids or (flammability) cleanser, lest the electric shock or fire disaster happens.





## Sterilizer air disinfectant virus killer

### Notice

- Please place the appliance at room temperature for 30 minutes for the initial use.
- Do not allow wet hands to unplug in order to avoid electric shock.
- A loose fit between the plug and AC outlet may cause overheating. Make sure of good connection between the plug and AC outlet.
- Please place & use the air humidifier on a dry, stable, flat and horizontal surface.
- Do not place the air humidifier under the air conditioner directly to avoid the condensed water.
- Do not place anything water-funk such as books under the fogger and appliance.
- Use at normal room temperature (Temperature is 5°C ~40°C, relative humidity < 80%RH).
- Before turning on the power, make sure that the water tank is well properly installed and add water according to the instruction.
- Do not hit the air humidifier with hard objects.
- Do not insert fingers or any other objects into air inlet and air outlet.
- Do not use the air humidifier around humid surrounding or high temperature such as bathroom, washroom or kitchen, and where combustible gases, heating appliances or vapors are present.
- Do not reserve the air humidifier while the power is on and water inside, so as to avoid burning the internal electronic components.



## Sterilizer air disinfectant virus killer

### Tips for using air humidifier

The most comfortable surrounding humidity for human	45~65%RH
The most advantageous surrounding humidity for disease control & treatment	40~55%RH
Surrounding humidity for computer & telecom equipment	45~60%RH
Surrounding humidity for household & musical instruments	40~60%RH
Surrounding humidity for library, art gallery & museum	40~60%RH

### Common problems and troubleshooting

Malfunction	Cause Analysis	Processing Method
Light is out, without wind, without fog	No power	Reconnect the power
Light is on, but without wind, without fog	Water level of the water tank is too high	Pour some water out of the water tank and screw the knob
Little fogmeter	Transducer with water scale	Clean the transducer
	Dirty water or water stored for long time	Replace clean water
Water mist overflow from the nozzle	Cracks between spray nozzle and water tank	Soak the spray nozzle before using
Water can not reach the base	Dirty knob or improper placement of the water tank	Clean the knob cover and replace the water tank
Water shortage alarm with water in the water tank	Whether water shortage protective floater is installed and normally works	Install the water shortage protective floater in place
Stop working in the process of use	Room humidity reaches the desired humidity	If humidify continuously, please turn off the humidity function and adjust the temperature
Abnormal noise	Little water in the water tank	Add water into the water tank
	Desktop resonance	Place on a solid desktop



## Sterilizer air disinfectant virus killer

### Routine maintenance

Since different regions' water contains different calcium & magnesium ion, etc., even water purify. When air humidifier works, some of them sprayed with water mist & then become whitening after drying. Some of them become water scale in air humidifier. Please clean the water scale & increase the effect of air humidifier.

#### 1. How to keep air humidifier clean?

- Use pure water to humidify.
- Clean the transducer, water tank & machine base weekly. Change the water in time. If the air humidifier is not used for a long time, do not keep water in the water tank & water channel.
- Do not use hard objects when cleaning to avoid scratching the transducer.
- When clearing away, please clean and wipe up every part of the air humidifier, or air-dry the water.

#### 2. How to clean the transducer and machine base?

- Before cleaning, please be sure to turn off the power and unplug the power plug.
- Pour the chemical detergent into the machine base and add warm water at about 60 degrees to make all the detergent devolves, then soak for 5~10 minutes.
- Wash the surface with a clean brush until the scale removed.
- Meanwhile clean the machine base and the transducer surface.



## Application Scenario

Provide professional technical and tutoring installation for free



Supermarket



Apartment lobby



Restaurant



Schools



hotel lobby

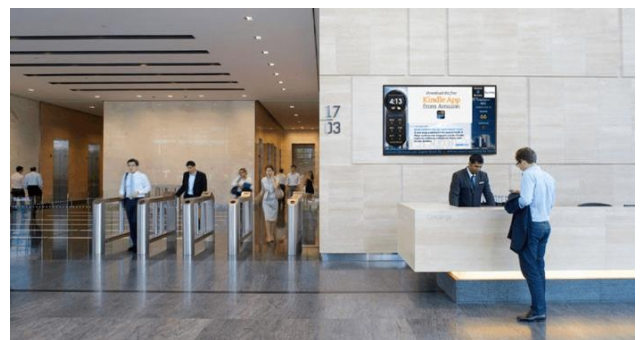

office lobby

## Multitasking Corporation Ltd

289 Dagang san Road Beilun District Ningbo Zhejiang ,China.  
647, Yeogsam-Dong, Gangnam-gu, Seoul, Korea  
301-307, Lockhart Rd, Wan Chai, Hong Kong  
2 Main Street, Suite 310, Stoneham, MA, 02180, USA  
Clarke Road, Milton Keynes, Buckinghamshire, MK1 1ZR, UK  
Email: [info@multitaskingcorporation.com](mailto:info@multitaskingcorporation.com)

